



Enscope - Smart Switch 10-18



Smart Switch User Manual

SSM001 | Issue No 1 | February
2020

Important Safety Information

This manual may not be altered or reproduced in whole or in part by any means without the express written consent of Best Energy Saving Technology Ltd.

The information contained in this document is believed to be accurate at the time of publication, however, Best Energy Saving Technology Ltd assumes no responsibility for any errors which may appear here and reserves the right to make changes without notice.

Please read this manual carefully before installation, operation and maintenance of the Smart Switch unit. The following symbols in this manual are used to provide warning of danger or risk during the installation and operation of the unit.



Electric Shock Symbol: Carries information about procedures which must be followed to reduce the risk of electric shock and danger to personal health.



Safety Alert Symbol: Carries information about circumstances which if not considered may result in injury or death.

Installation and maintenance of the Smart Switch should only be performed by qualified, competent professionals who have received training and should have experience with current devices.

Best Energy Saving Technology Ltd shall not be responsible or liable for any damages caused by improper installation.

Considerations When Installing the Smart Switch

Installation of the Smart Switch must be performed by qualified personnel only, who follow standard safety precautions through the installation procedures. Those personnel should have appropriate training and experience of Aircon systems and electrical systems. Appropriate safety gloves, safety glasses and protective clothing are highly recommended.

During normal operation the device uses DC voltage and low current draw, But DC voltage can still be dangerous and may appear on parts of the Smart Switch, including the exposed circuit boards (when unit open). AVOID contact with any current-carrying surfaces.

The Smart Switch is NOT designed as primary protection devices and shall NOT be used as primary circuit protection or in an energy-limiting capacity. The Smart Switch can only be used as secondary protection. AVOID using under situations where failure of the Smart Switch may cause injury or death. AVOID using the Smart Switch for any application where risk of fire may occur.

Applying more than the maximum voltage to the Smart Switch will permanently damage the unit. Please refer to the specifications for all devices before applying voltages.

- Best Energy Saving Technology Ltd recommends using a dry cloth to wipe the The device.

Important Note: if the equipment is used in a manner not specified by the Manufacturer, the protection provided by the equipment may be impaired.

Smart Switch Description

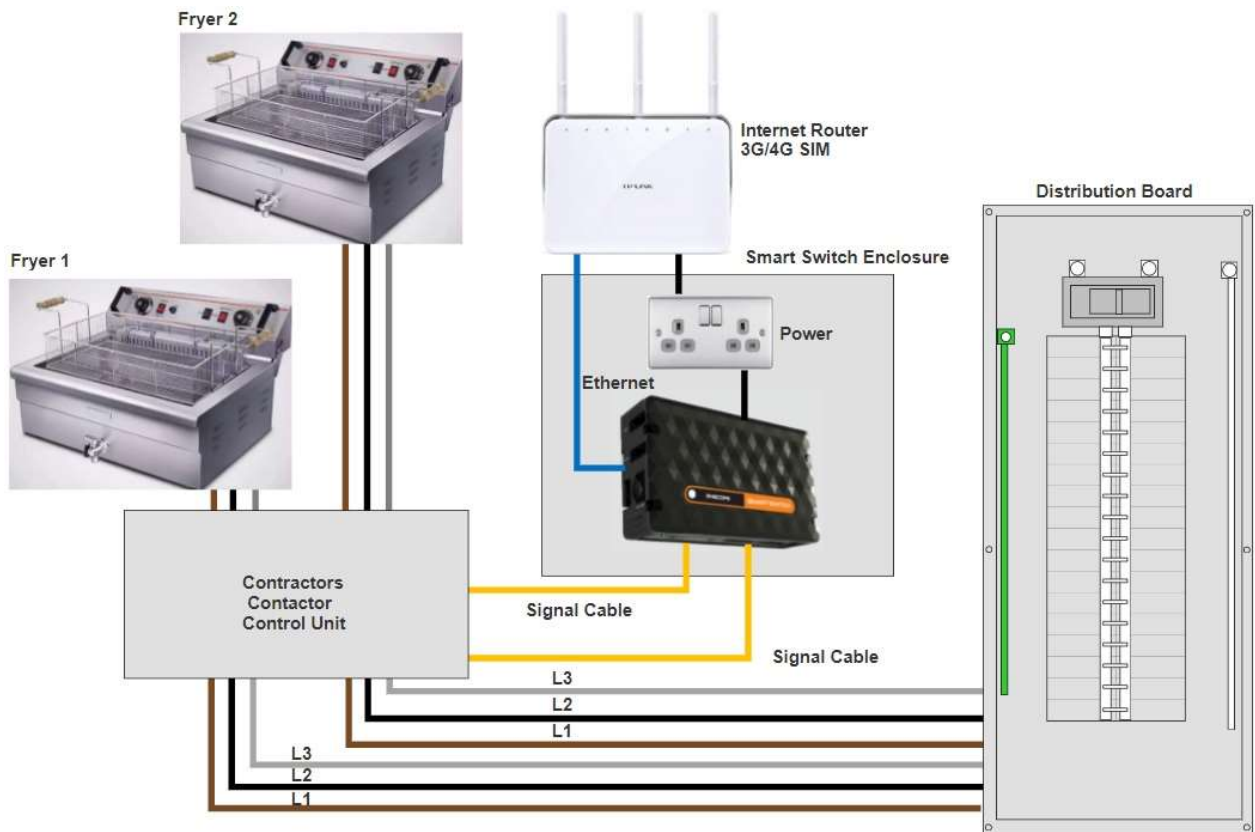

Smart Switch is a plug-and-play system, easily and safely installed by an electrician. That functionality can work on the basis of logic controls; a set of rules which, if satisfied, ‘trigger’ the on or off function. Or you can control it manually, switching equipment off yourself when you see (with Eniscop’s analytics) that consumption is excessive or active out-of-hours, for example.



The Smart Switch uses on-board software to display live input readings, and allow you to programme the logic controller and switch your output relays on or off manually.

You can also view your data remotely on graphs dating back a month or in table format via MQTT.

From this website you can setup remote scheduling for your aircon systems, such as ensuring they off outside of operating hours.

The Smart Switch has 5 output relays allowing you to control up to 5 systems per unit.



Smart Switch Identification

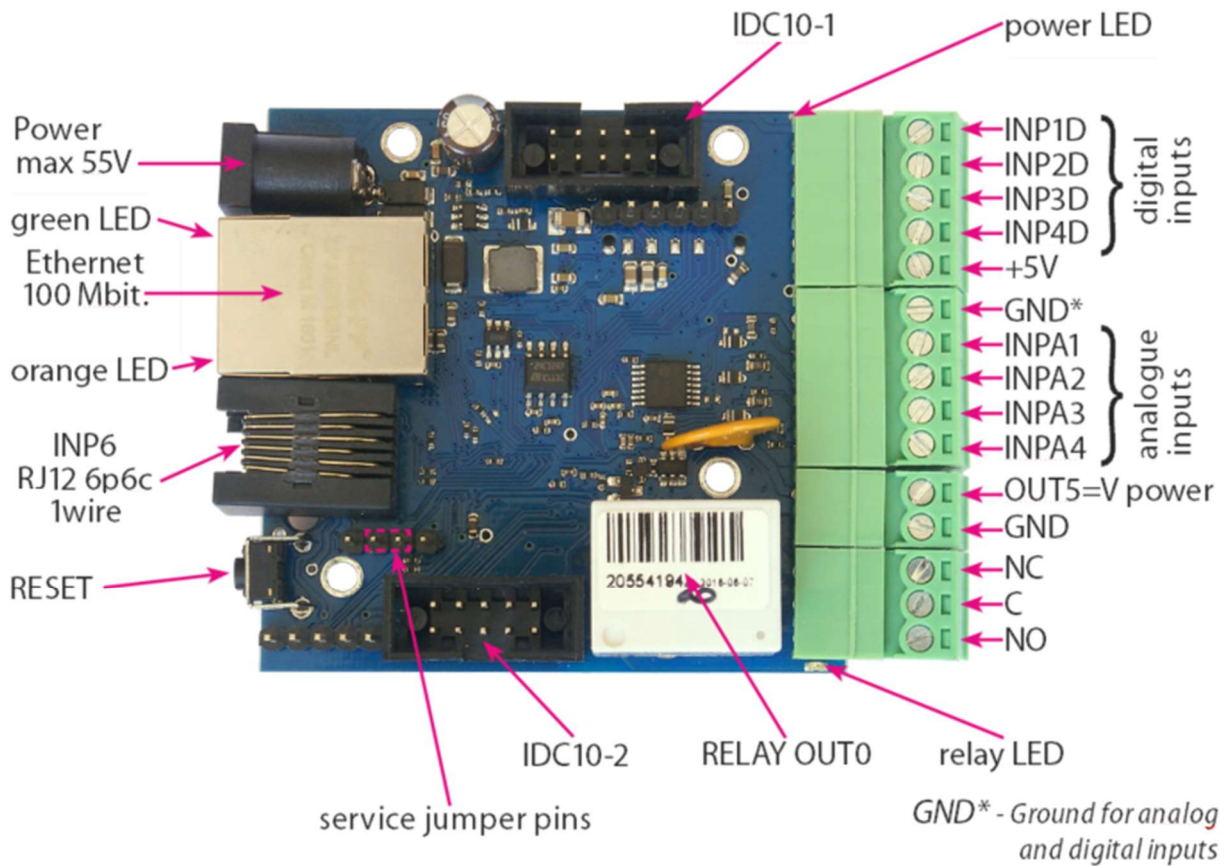

PIN/Component	Description
Power	Power supply 8V ÷ 55V DC
power LED	LED indicator on – power on board
relay LED	LED indicator on – relay active
green LED	LED indicator on – eth link active
orange LED	LED indicator on – data transmitted
IDC10-1	Additional Inputs / Outputs PWM1 ÷ 3
IDC10-2	Additional outputs transistor OC standard, for example, relays
INP1D ÷ INP4D	Logical inputs Low=0~0,8V, High=0,8V~20V Also supports a pulse counter
+5V	For sensors supply
GND*	Ground for analog and digital inputs
INPA1 ÷ A4	Analog inputs
OUT5	Transistor output (+), voltage = power supply, max 1A
GND	Ground for transistor output (-)
NC	Relay OUT0, normally closed contact
C	Relay OUT0, common contact
NO	Relay OUT0, normally open contact

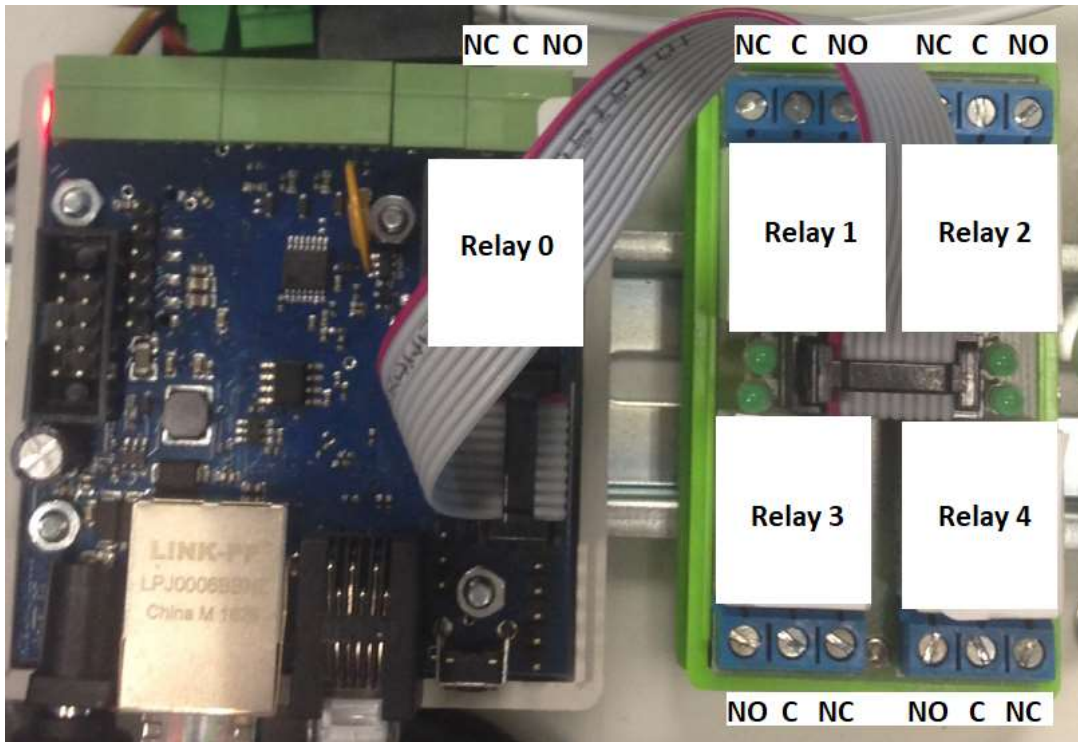

Note: The Relay circuit board has the numbers identification printed on the board.

SECTION 1

INSTALLATION

Important Safety Notice

SAFETY AT WORK



The owner, installer and user of this Smart Switch device are responsible for its correct installation and use, and must ensure that;

- a) Only qualified persons install the unit.
- b) Isolate Power Supply before installation.
- c) The installation complies with the information contained in this publication.
- d) All units must be installed in accordance with the current National Electrical Code.

Best Energy Saving Technology Ltd, or their agents do not assume any liability, expressed or implied, for any consequences resulting from inappropriate, negligent or incorrect installation, application, use or adjustment of this device.

A. Mounting the Smart Switch

Opening the Smart Switch

There are 4 screws on the back of the Smart Switch Enclosure, once removed the front lid will come off and you can see the boards inside.

Please note you will need to screw the lid down again before final mounting to the wall.

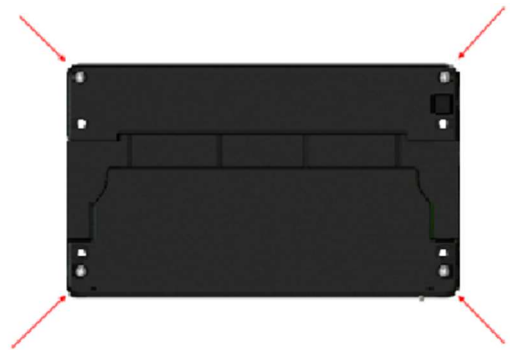

Environmental

There are no specific ventilation requirements however, please check the environment, temperature and humidity to ensure the Smart Switch is within the correct operating conditions. Also before you begin to mount the Smart Switch.

The Smart Switch is Type 1, for indoor use only.

Mounting Holes

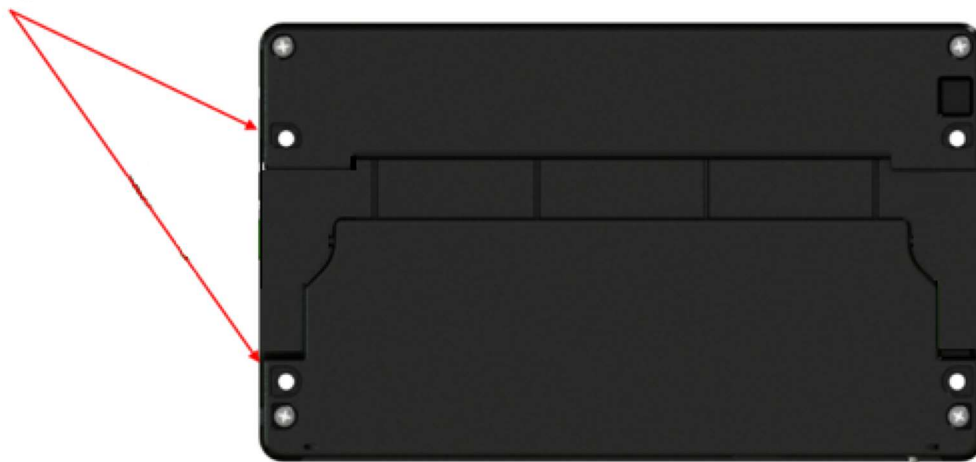

Mounting Holes

The Smart Switch is designed to be mounted on a vertical surface within an electrical cabinet or wall mount, using the provided glands for incoming cables. The Smart Switch can be mounted using the corner mounting holes.

Dimensions

Height 144 mm

Width 236 mm

Depth 60 mm



B. Location

Smart Switch Location

You will need to consider the best location of the Smart Switch unit to get all the connectivity options.

The Smart Switch unit will need:

- Internet access via rj45
- Wall socket (100-240V) for power point
- 2 wire cable for each system connected (can support up to 5 systems)

Normally we see partners installing the Smart Switch unit near the Eniscope (So they can share the same network access point and use the Eniscope earth point).

C. Cables



Power Cable

The unit comes with a UK plug end and a 110-240v supply, (The Smart Switch requires 8 to 55V DC supply) to plug into a wall socket, we recommend you use an existing wall socket point or create one from the Distribution board with a switch. If your country uses a different plug you can keep the power supply and just get a cable with figure 8 C7 adaptor or replace the plug directly.

Ethernet Cable

Run the Ethernet cable between your Smart Switch unit and the nearest internet access router so data can be uploaded to the MQTT site and remote instructions can be sent to the unit.

System Control cables

Please use 26AWG 2 wire (1 pair) or larger, you will need 1 cable per system (5 systems max) and all cables must lead back to the Smart Switch unit.

If using the relays for current bearing instead of signal, they are rated for up to 10A, but should only be used to activate a coil for external contactor/relay or low power signal.

When wiring your system to the Smart Switch, please use the **Common** (middle point of each relay) and the **NO** (normally open) points for your 2 wire connection.

This will mean then in the software a **0 (out=0) will result in system off** and **1 (out=1) will switch the system on** for standardisation.

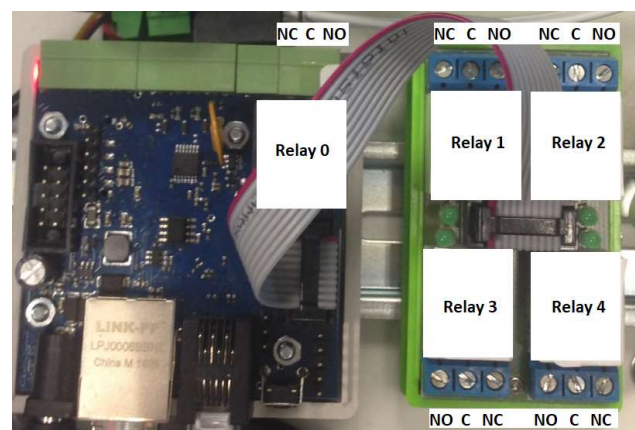

D. Smart Switch Access and Network Setup

Login

Login using the default IP 192.168.1.100 and user admin, password admin. You can login by typing the IP into the browser like with Eniscope (but do not need /admin).

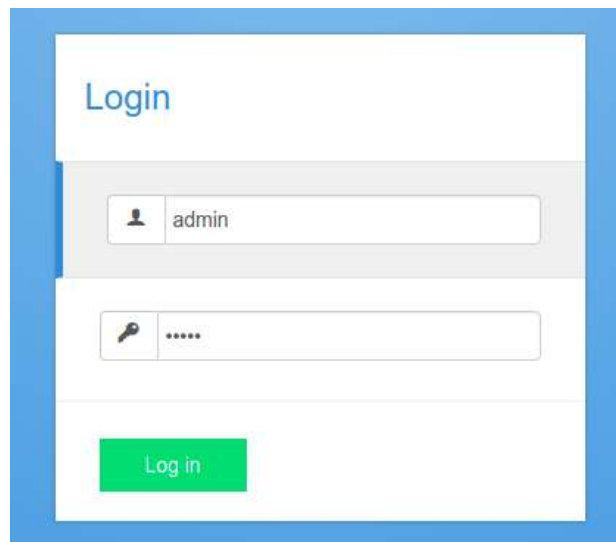

You will find it best to connect to the Smart Switch unit with a direct cat5 cable from your laptop (bypass any router for now).

Setting the IP Address

Click 'Config/Network', Change the IP settings to the required static IP, do not use DHCP.

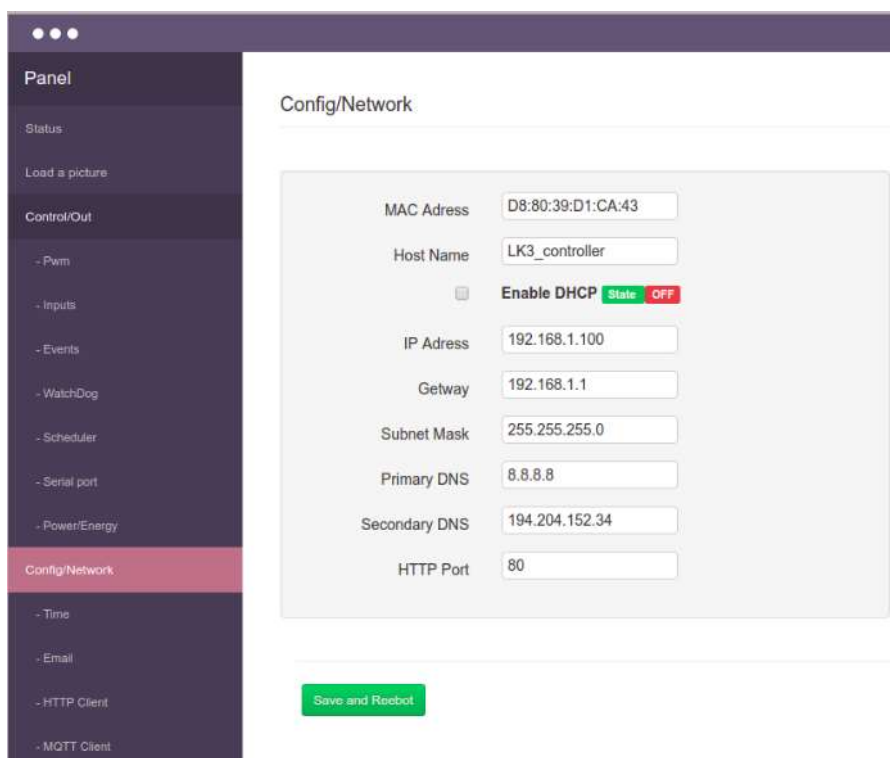

Now press 'Save and reboot' option, please remember to login in again on the new IP address. Remember that it is important to put in the correct IP range, gateway and DNS settings that match your router. After the settings are correct, you can connect both your Smart Switch unit and your laptop to the router.

Set the Time

Click the 'time' menu option and select the NTP option (or set the time manually) and save. Also click the 'set time in RTC' to save to controller. Also you can select your timezone.

Panel

Status

Load a picture

Control/Out

- Pwm
- Inputs
- Events
- WatchDog
- Scheduler
- Serial port
- Power/Energy

Config/Network

- Time
- Email

Time

Current time 2018-10-15;12:47:58

NTP

Set manual 1970-01-01;01:01:32

NTP Servers pool.ntp.org

Port 123

Time interval 600

Time zone 1

Automatic daylight saving time

To check the operation is successful go to the 'status' screen and check the date and time displayed up top.

Status

UpTime 46 sec, 14 min, 0 hour, 0 day ... 2018-11-15;10:33:02 Version: 1.49b1 VCC SUPPLY = 12.2 V Temperature = 32 C

E. Testing the Control of your Devices

With your systems wired in to the Smart Switch, you need to check that switching the output/relay creates the desired on/off state. Please conduct the below test and we would recommend using our Verification sheet or form for record keeping (see support desk for download).

Off (0) Test

For each system connected you need to check that when you send a 0 for the output (i.e. out1=0) the system is off.

Make sure the attached system switches off and wait at least 10mins to ensure there is no problem.

On (1) Test

For each system connected you need to check that when you send a 1 for the output (i.e. out1=1) the system is on.

Make sure the attached system switches on and wait at least 10mins to ensure there is no problem.

F. Adding your Device to ACES2.eniscope.com

Select the 'MQTT Client' in the Smart Switch to set up communications and then in a browser type: aces2.eniscope.com

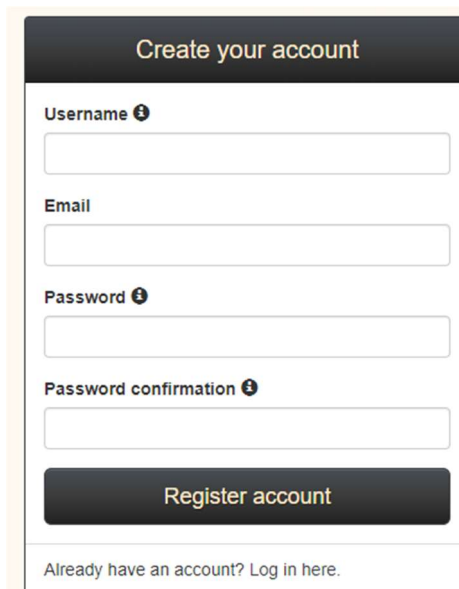

The image shows a web form titled "Create your account". It contains four input fields: "Username", "Email", "Password", and "Password confirmation". Each field has a small information icon to its right. Below the fields is a dark button labeled "Register account". At the bottom of the form, there is a link that says "Already have an account? Log in here."

Login to your account, if you don't have an account yet you can create one for free.

Now enter a name for the Smart Switch and choose the LK3 option. Click add device.

To add a new device: (click to see more)

Name

Type

Redirect afterwards

Now enter a name for the Smart Switch and choose the LK3 option. Click add device.

You will now be asked to tick the 'active' box for the parameters you wish to see on the cloud.

<input checked="" type="checkbox"/>	<input type="text" value="n05c0b/a59/out0"/>	<input type="text" value="OUT0"/>	<input type="checkbox"/>
<input checked="" type="checkbox"/>	<input type="text" value="n05c0b/a59/out1"/>	<input type="text" value="OUT1"/>	<input type="checkbox"/>
<input checked="" type="checkbox"/>	<input type="text" value="n05c0b/a59/out2"/>	<input type="text" value="OUT2"/>	<input type="checkbox"/>
<input checked="" type="checkbox"/>	<input type="text" value="n05c0b/a59/out3"/>	<input type="text" value="OUT3"/>	<input type="checkbox"/>
<input checked="" type="checkbox"/>	<input type="text" value="n05c0b/a59/out4"/>	<input type="text" value="OUT4"/>	<input type="checkbox"/>

Please tick out0 to out5 and any additional parameters you are using.

Click save series settings when done.

Series group **Smart Switch 2** (with device)

Name change If your LK3 is in the same network as you are (you can access it in your browser), then you can quickly configure its MQTT client without need to edit its settings manually.

Quick Configuration Simply choose series you want to monitor in Series settings, then go back here and enter address of your LK3 in the field below and confirm with button next to it.

Series settings **Note** In case you have already enabled authentication on your LK3, type in field below also your login credentials to device (they will not be stored or even sent to server, but used just once to access your LK directly from your browser). Generally it should be in following format:

Chart settings

Manage databases

In case you would like to use old edit page go here. However new version offers better load times and hopefully better division of content.

Now on the left hand menu select 'quick configuration' (note this will only work if your computer is on the same local network as the Smart Switch). Type in the IP address of the unit and click 'Perform Quick Configuration'.

MQTT CONNECTED

Your device number 910F00

Enable Mqtt

Enable log/pass auth

Server address

Port

Login

Password

Prefix

Time

Ping Time

INPA1 INPA2 INPA3 INPA4 INPA5 INPA6 INPA1R INPA2R
 INPA3R INPA4R INPA5R INPA6R DS1 DS2 DS3 DS4
 DS5 DS6 DS7 DS8 VCC TEMP T1 H1 DIFF1
 DIFF2 INPID1 INPID2 INPID3 INPID4 OUT0 OUT1 OUT2
 OUT3 OUT4 OUT5 POWER1 POWER2 POWER3 POWER4
 ENERGY1 ENERGY2 ENERGY3 ENERGY4 PM2.5 PM10 P1
 CO2

You can now return to the Smart Switch web menu and refresh the ‘MQTT Client’ menu. You should find that the MQTT is Connected (top left in green background) and that the connection settings have been filled in for you.

If you have trouble with the quick configuration you can also set the MQTT connection manually, to do this go back to Devices menu

Now click on the blue banner titled ‘to add a new device’ and follow the instructions.

To add a new device: (click to hide)

1. Complete the form below.
2. Confirm with button **Add device** and wait until you are redirected and are shown results (success or errors message).
3. Choose data/series that interest you in **Series settings** inside **Edit** section.
4. Configure your device's **MQTT client** settings. There are 2 ways to do it for LK3.
 - A. **Recommended for LK3** Use **Quick Configuration** from **Edit** section (details on its page).
 - B. Manually enter data in form in LK3's **MQTT Client** tab:

Enable Mqtt	select it
Enable log/pass auth	select it
Server address	copy and paste mqtt.ats.pl
Port	copy and paste 1883
Login	copy and paste david.bowers
Password	copy and paste 0ce7f26c2c
Prefix	copy value of prefix generated for chosen device
Time	leave the default value or enter 300
Ping Time	leave the default value

Select at least one checkbox so LK3 will be actually sending data.
Approve changes by clicking **Save**.

 The picture showing valid configuration of LK3.

G. (Optional) Events and Temperature/Humidity

A normal setup of the Smart Switch does not require onboard logic setup or temperature/humidity sensors data. But the options are there if you like to add to your installation.

For more detailed explanation and example of onboard logic via the Events screen or integration with temperature sensors, please refer to the ACES2 Manual for full details. Below know is a summary of how the events page works.

The screenshot shows the 'Events' configuration page. It includes a sidebar with navigation options like Panel, Status, Control/Out, and Events. The main area is titled 'Events' and contains two event configuration blocks. Each block has fields for sensor type (Analog/Digital), input ID (INP1D), comparison operator (if), threshold value (Value), and hysteresis (+hysteresis). Below these are logic operation tables for AND, OR, NOR, NAND, and XOR. The 'Event list' table at the bottom shows two configured events for DS2 and DS3 sensors, both set to trigger when the value is greater than or equal to 30 with a hysteresis of 1.5. The output is set to 'OR' and 'Out1=1', with an 'On' tick box checked.

On the Events screen we can see the programmable logic for setting our relay outputs based on the temperature or digital/analogue inputs thresholds.

1. Select the temperature sensor(s) or digital/analogue input you wish to monitor.
2. Select if the relay switching should be when temperature is equal to or greater than or below option (i.e. switch when equal to or above 30 degrees, switch when below 20 degrees).
3. Set the temperature threshold for switching (i.e. 30 degrees).
4. Set the hysteresis or leave as default 1. This will mean the for example if threshold is 30, that the relay will switch on at 31 degrees (with hysteresis set to 1), then switch off again at 29 degrees.
5. Select your Logic operation, if in doubt, keep to an 'OR' for most applications. Examples are displayed on screen.
6. Select the Relay outputs (output 0-4 and 1 for on, 0 for off). Don't select Auto as this is a continuous toggle on/off.
7. Once the configuration is complete hit the 'add config' to save.
8. To turn the configuration on select the On-tick box.

SECTION 2

COMMISSIONING OPTIONS

A. Device Menu

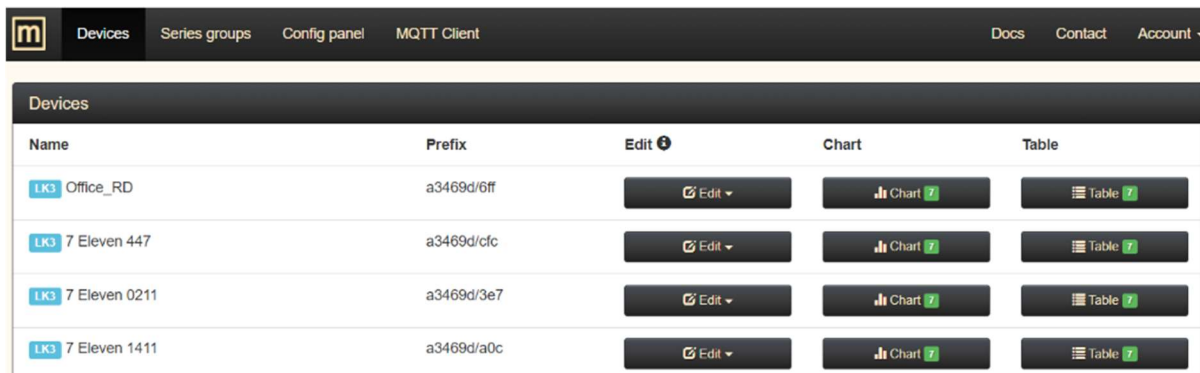

Name	Prefix	Edit	Chart	Table
LK3 Office_RD	a3469d/6ff	Edit	Chart	Table
LK3 7 Eleven 447	a3469d/cfc	Edit	Chart	Table
LK3 7 Eleven 0211	a3469d/3e7	Edit	Chart	Table
LK3 7 Eleven 1411	a3469d/a0c	Edit	Chart	Table

Under the Device menu selection, you can see your Smart Switch listed and besides them is a chart and table option.

Status Chart

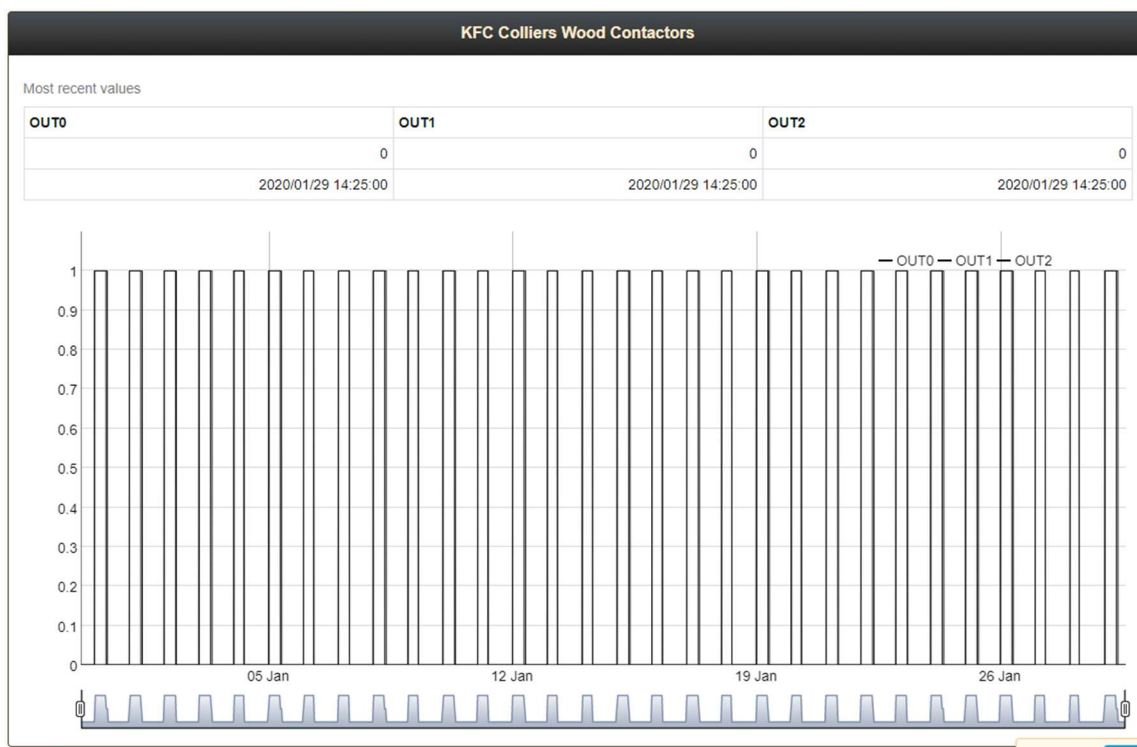

Selecting the chart option, you can see data for the last month for the Smart Switch outputs (or sensors) and review the schedule status.

Outputs Table

Table for 7 Eleven 1411

Click here to see information about CSV export

Download data in CSV format

Search

Date	DS1	OUT0	OUT1	OUT2	OUT3	OUT4	OUT5
2019-08-08 14:30:00	26.4	0	0	0	0	0	0
2019-08-08 14:25:00	26.5	0	0	0	0	0	0
2019-08-08 14:20:00	26.1	0	0	0	0	0	0
2019-08-08 14:15:00	26.6	0	1	1	1	0	0
2019-08-08 14:10:00	26.8	0	0	0	0	0	0
2019-08-08 14:05:00	26.5	0	0	0	0	0	0
2019-08-08 14:00:00	26.3	0	0	0	0	0	0
2019-08-08 13:55:00	26.2	0	0	0	0	0	0
2019-08-08 13:50:00	26.7	0	1	1	1	0	0
2019-08-08 13:45:00	26.8	0	0	0	0	0	0

Showing 1 to 10 of 20214 rows 10 rows per page

1 2 3 4 5 ... 2022

Here you can analyse your Smart Switch system more closely than the chart and compare the various output states against the Eniscope recorded energy use to see if the schedules are working and the improvements you are making.

Data Download

Table for 7 Eleven 1411

Click here to see information about CSV export

Download data in CSV format





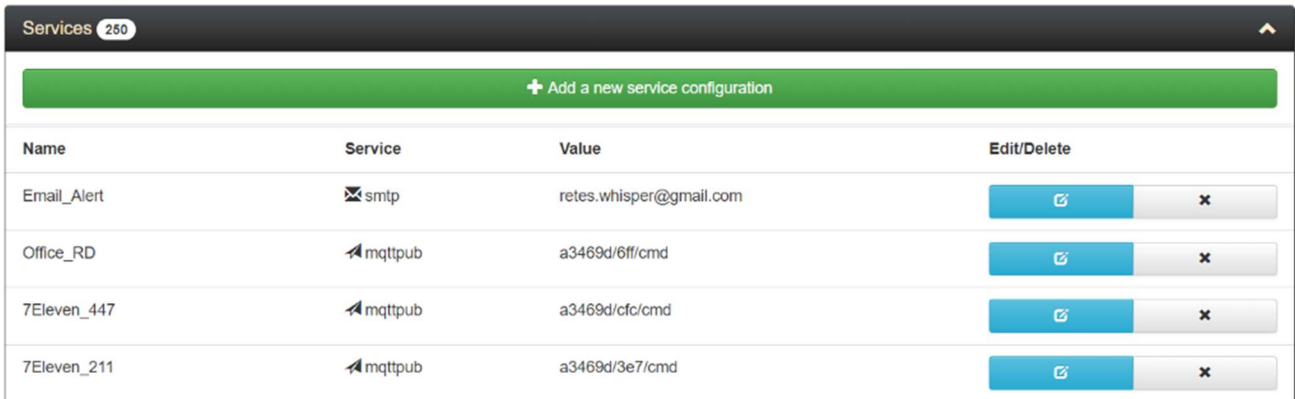

Choose date format	DS1
ISO	26.4
UNIX	26.5
locale-native	26.1
locale-moment	26.1
standard	26.6

On top of the Table screen you have the ability to download the data in a CSV format.

B. Control Panel menu

Services

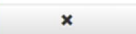







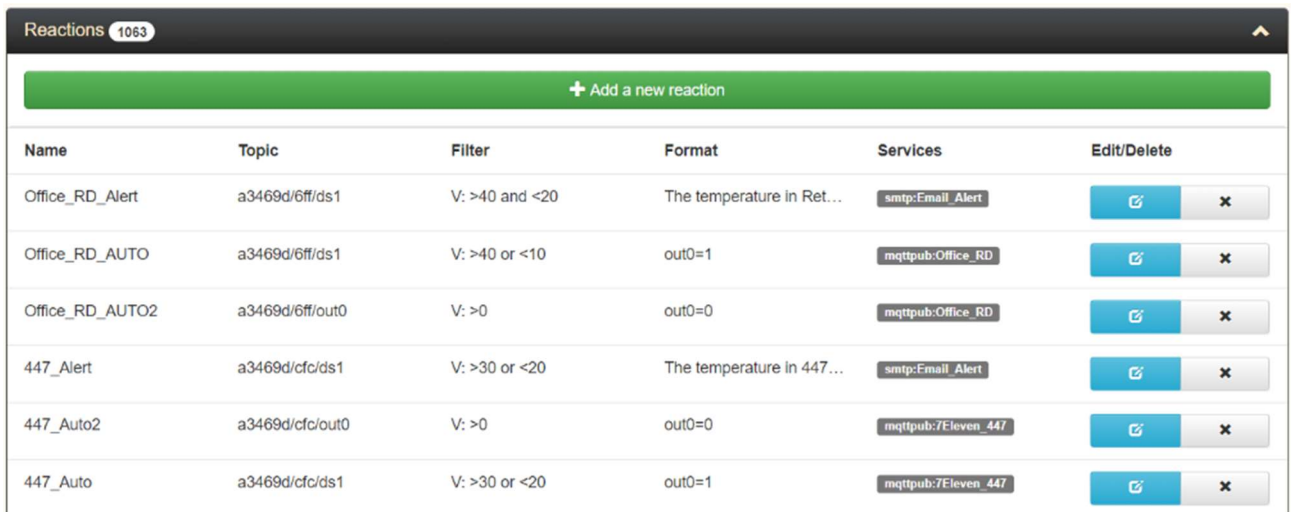





Name	Service	Value	Edit/Delete
Email_Alert	✉ smtp	retes.whisper@gmail.com	 
Office_RD	🔊 mqttpub	a3469d/6ff/cmd	 
7Eleven_447	🔊 mqttpub	a3469d/cfc/cmd	 
7Eleven_211	🔊 mqttpub	a3469d/3e7/cmd	 

This section is where you can set the address of the items we want to communicate with, in this case we use the smtp service to publish a message to an email and the mqttpub service to point to the CMD (command console) of a particular Smart Switch unit we wish to control.

(Optional) Reactions



Name	Topic	Filter	Format	Services	Edit/Delete
Office_RD_Alert	a3469d/6ff/ds1	V: >40 and <20	The temperature in Ret...	smtp:Email_Alert	 
Office_RD_AUTO	a3469d/6ff/ds1	V: >40 or <10	out0=1	mqttpub:Office_RD	 
Office_RD_AUTO2	a3469d/6ff/out0	V: >0	out0=0	mqttpub:Office_RD	 
447_Alert	a3469d/cfc/ds1	V: >30 or <20	The temperature in 447...	smtp:Email_Alert	 
447_Auto2	a3469d/cfc/out0	V: >0	out0=0	mqttpub:7Eleven_447	 
447_Auto	a3469d/cfc/ds1	V: >30 or <20	out0=1	mqttpub:7Eleven_447	 

Reactions section has a large variety of usage, we can set alerts so that when a sensor goes outside a set range it send an email alert. We can also set an auto trigger to disconnect and reconnect a sensor when failed.

In a standard Smart Switch install you do not require to install a sensor and therefore the reactions section can be left blank, but the option is there if ever needed. Please refer to the ACES2 manual for examples of logic with reactions.

Tasks (Schedule)

Tasks 940				
+ Add a new task				
Filter by name	Filter by topic	Number of shown results		
<input type="text"/>	<input type="text"/>	20	20 of 940 matches	
Name	Topic	Message	Send on	Edit/Delete
Office_RD_AC_ON	a3469d/6ff/cmd	out4=0	07:00:00 Monday, Tuesday, Wednesday, Thursday, Friday	
Office_RD_AC_OFF	a3469d/6ff/cmd	out4=1	19:00:00 Monday, Tuesday, Wednesday, Thursday, Friday	
447_AC1_ON	a3469d/cfc/cmd	out4=0	07:00:00 Monday, Tuesday, Wednesday, Thursday, Friday, Saturday, Sunday	
447_AC1_OFF	a3469d/cfc/cmd	out4=1	19:00:00 Monday, Tuesday, Wednesday, Thursday, Friday, Saturday, Sunday	
447_AC2_ON	a3469d/cfc/cmd	out5=0	19:00:00 Monday, Tuesday, Wednesday, Thursday, Friday, Saturday, Sunday	
447_AC2_OFF	a3469d/cfc/cmd	out5=1	07:00:00 Monday, Tuesday, Wednesday, Thursday, Friday, Saturday, Sunday	

The task section is essentially where we can schedule systems on or off during the days specified. For instance for a 24hour store with 2 AC, we can schedule one AC for 12hours and the other for the next 12hour.

C. MQTT Client

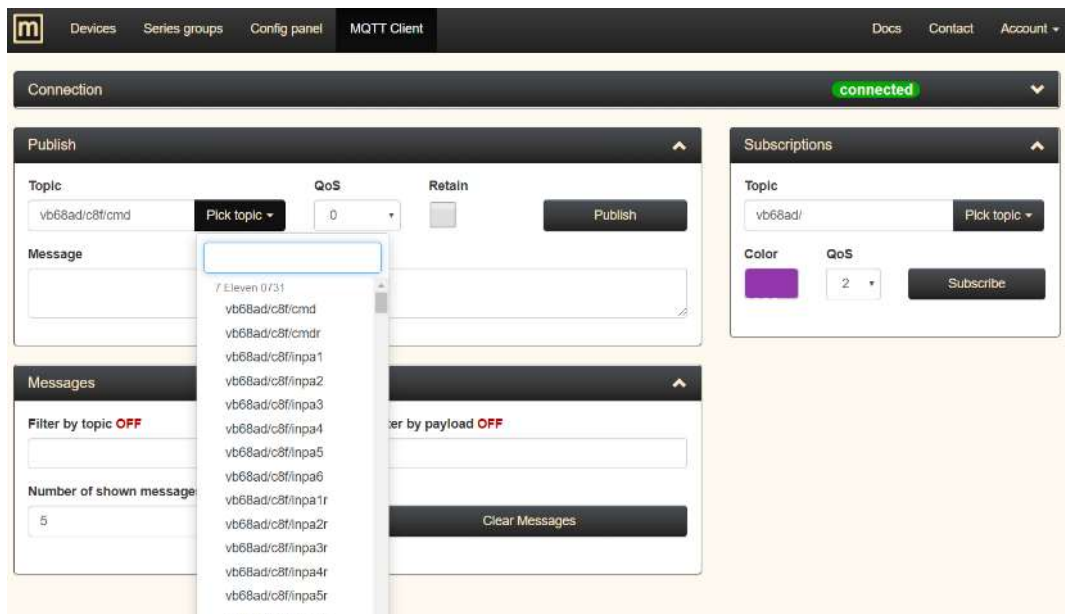

The MQTT client can be used to send instant manual commands remotely, firstly check for the green connected symbol in top right corner. Next select topic and choose the cmd (command console) of your device. Now type the output you wish to switch the state of and hit Publish.

i.e. out0=1

Note: the system is capital lock sensitive, so use lower case

D. Making Edits in ACES2.Eniscope.com

When you want to add new commands to Reactions, Tasks or MQTT Client you need to login via incognito window. This ensure no one can accidentally change setting while viewing.

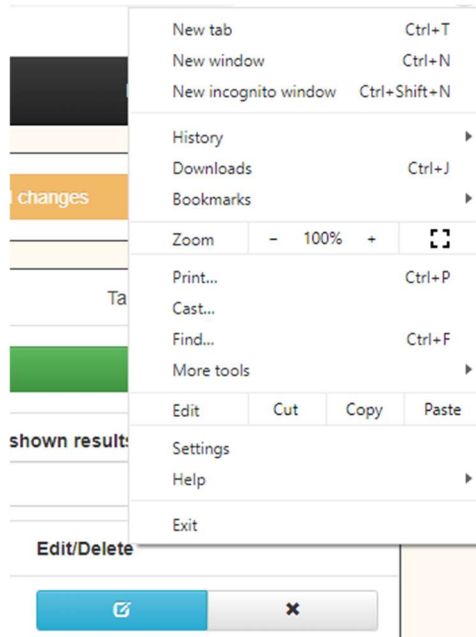

All major browsers have a incognito mode and above is an example for google chrome.



If the mode is working correctly you will see the MQTT On in the bottom left corner.

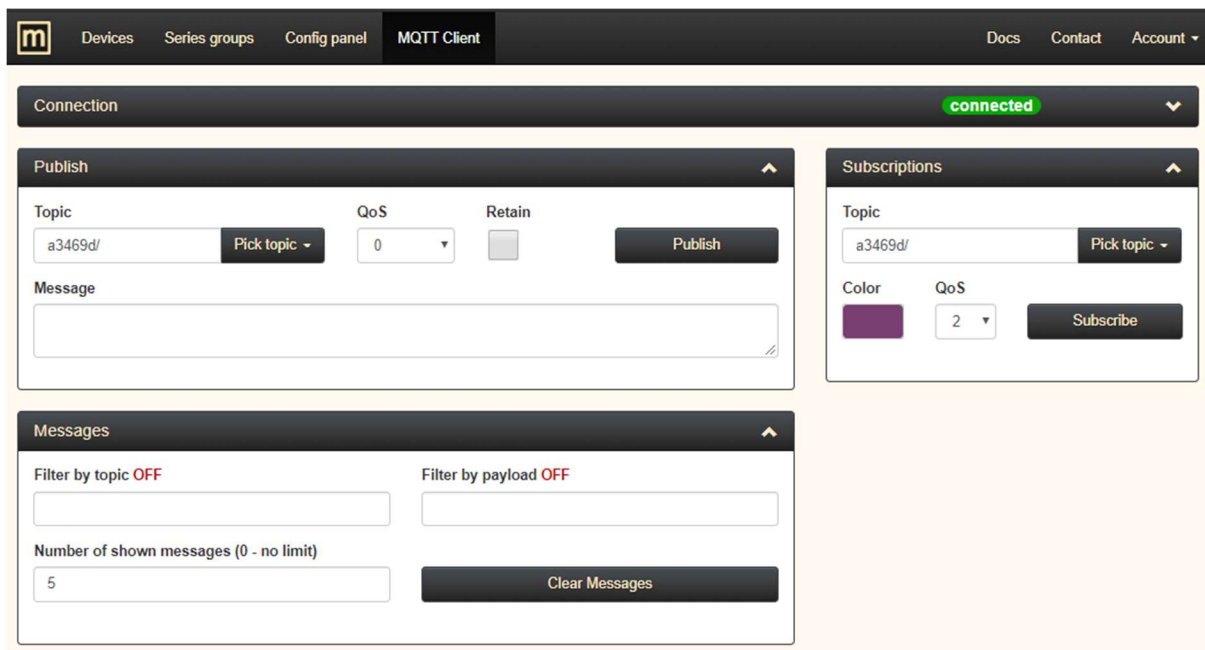

Or you will see the Connected sign for the MQTT Client

SECTION 3

TROUBLESHOOTING

A. Factory Reset

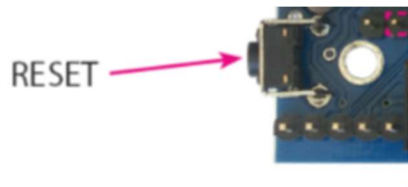

Pressing the reset button for about 0.5 seconds to change state relays, and hold for longer (up to five seconds) will change all settings (both network and configuration) on the factory reset.

Confirmation of the settings is fast switching on and off the relay.

SECTION 4

SPECIFICATIONS

Supply voltage: 8 to 55 V DC
Power consumption: 0.5W
Interface: Ethernet 100 Mbit/s
Relay: 255 V AC 10 A
Operating temperature: -20 to +85 °C

INPUT / OUTPUT:

4 Analogue Inputs INPA1 to INPA4 with amplifier
2 input voltage ranges:

The scope of of measured voltage for a range of 3.3 V
gain=1 from 0 to 3300 mV
gain=10 from 0 to 330 mV
gain=50 from 0 to 60 mV

The scope of of measured voltage for a range of 33 V

gain=1 from 0 to 33000 mV
gain=10 from 0 to 3300 mV
gain=50 from 0 to 600 mV

for voltages between 0 to 5 mV, the measurement is not sure.

2 Analogue Input without gain INPA5 & INPA6:
range of measured voltage of 0.1 to 3.3 V

1 Digital Input in standard 1-WIRE and I2C (connector 6P6C RJ12):
measurement 6 temperature probes DS18B20.

4 Logic Input:
VLow - max 1,1 V
VHigh - min 1,5 V, max 12 V

RELAY:
10 A / 240 V AC, 15 A / 24 V DC